

AscenKorea Inc.

AKS6H GPS Standalone Module Datasheet

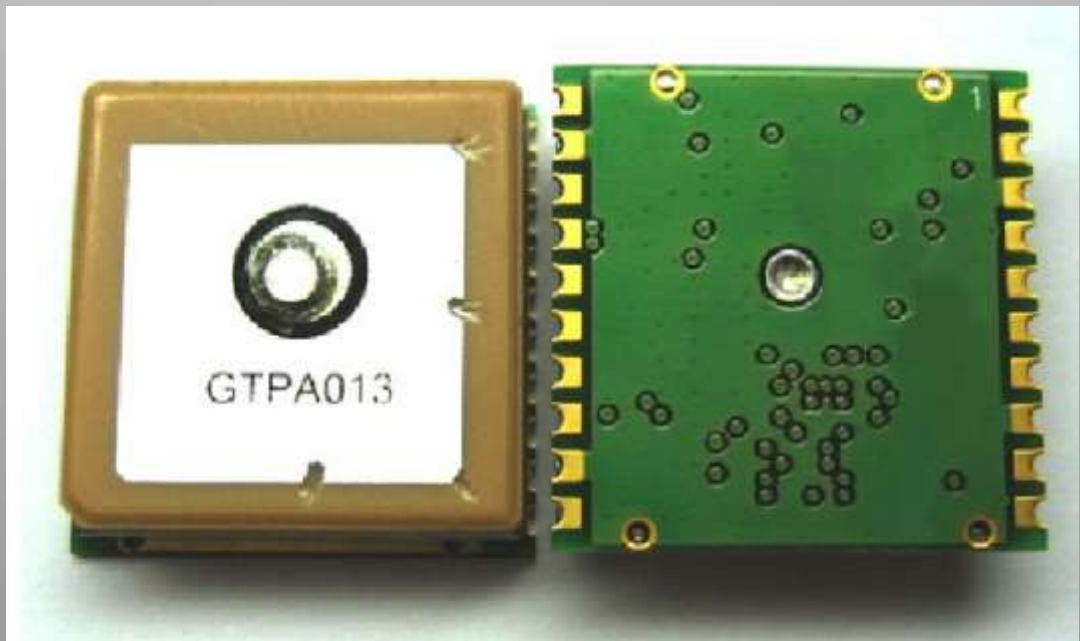

The AKS6H is a 4th generation stand-alone GPS module with lightning fast TTFF, ultra high sensitivity(-165dBm), and low power consumption in a small form factor(16*16*4.7mm)

This document is the exclusive property of AscenKorea Inc. and should not be distributed, reproduced, into any other format without prior permission of AscenKorea Inc. Specifications subject to change without prior notice.

AscenKorea Inc.

Rm. 710, 7F, Halla Sigma Velley B/D, Gasandigital 2Ro 53, Geumcheon-gu, Seoul, Korea
Tel: +82 02 858 7810 Fax: +82 02 858 7813/ www.AscenKorea.com /sales@ascen.co.kr

copyright © AscenKorea Inc. All right reserved



Version History

Title: Ascenkorea AKS6H Datasheet

Subtitle: GPS Module

Doc Type: Datasheet

| Revision | Date | Author | Description |
|----------|-----------|--------|-------------|
| V0A | 2012-1-31 | Dennis | Preliminary |
| | | | |
| | | | |
| | | | |



Table of Contents

- 1. Functional Description 4**
 - 1.1 Overview 4
 - 1.2 Highlights and Features..... 5
 - 1.3 System Block Diagram 6
 - 1.4 Multi-tone active interference canceller 7
 - 1.5 1PPS..... 7
 - 1.6 AGPS Support for Fast TTFF (EPO™)..... 7
 - 1.7 EASY™ 7
 - 1.8 AlwaysLocate™ (Advance Power Periodic Mode)..... 9
 - 1.9 Embedded Logger function 9
 - 2.0 Antenna Advisor 9
- 2. Specification..... 10**
 - 2.1 Mechanical Dimension 10
 - 2.2 Recommended PCB pad Layout..... 11
 - 2.3 Pin Configuration 12
 - 12
 - 2.4 Pin Assignment 13
 - 2.5 Description of I/O Pin..... 14
 - 2.6 Specification List 17
 - 2.7 Absolute Maximum Ratings 18
 - 2.8 Operating Conditions..... 18
 - 2.9 GPS External Antenna Specification (Recommended) 18
- 3. Protocols..... 19**
 - 3.1 NMEA Output Sentences..... 19
 - 3.2 Antenna Status Protocol (Antenna Advisor)..... 25
 - 3.3 MTK NMEA Command Protocols 25
 - 3.4 Firmware Customization Services 26
- 4. Reference Desgin 27**
 - 4.1 Reference Design Circuit..... 27
- 5. Packing and Handling 28**
 - 5.1 Moisture Sensitivity..... 28
 - 5.2 Tape Reel Packing Information 29
 - 1Kpcs/Reel 29
 - 5.3 Storage and Floor Life Guideline 32
 - 5.4 Drying..... 32
 - 5.5 ESD Handling 33
- 6. Reflow Soldering Temperature Profile 34**
 - 6.1 SMT Reflow Soldering Temperature Profile..... 34
 - 6.2 Manual Soldering 38
- 7. Contact Us..... 39**



1. Functional Description

1.1 Overview

The AKS6H utilizes the MediaTek new generation GPS Chipset MT3339 that achieves the industry's highest level of sensitivity (-165dBm) and instant Time-to-First Fix (TTFF) with lowest power consumption for precise GPS signal processing to give the ultra-precise positioning under low reception, high velocity conditions.

The module is a revision of POT (Patch On Top) GPS Module with an extra embedded function for external antenna I/O and comes with **automatic antenna switching function** and short circuit protection, also features an antenna system called "Antenna Advisor" that helps with the detections and notifications of different antenna statuses, including active antenna connection, antenna open circuit and antenna shortage.

Up to 12 multi-tone active interference canceller (ISSCC2011 award), customer can have more flexibility in system design. Supports up to 210 PRN channels with 66 search channels and 22 simultaneous tracking channels, Module supports various location and navigation applications, including autonomous GPS, QZSS, SBAS (note) ranging (WAAS, EGNOS, GAGAN, MSAS), AGPS.

AKS6H is excellent low power consumption characteristic (acquisition 82mW, tracking 66mW), power sensitive devices, especially portable applications, need not worry about operating time anymore and user can get more fun.

Note: SBAS can only be enabled when update rate is less than or equal to 5Hz.

Application:

- ✓ Handheld Device
- ✓ Tablet PC/PLB/MID
- ✓ M2M application
- ✓ Asset management
- ✓ Surveillance

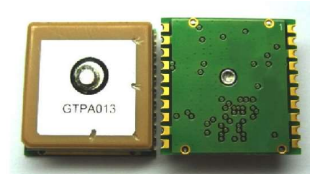



1.2 Highlights and Features

- ◆ Built-in 15X15X2.5mm ceramic patch antenna on the top of module
- ◆ Ultra-High Sensitivity: -165dBm (w/o patch antenna), up to 45dB C/N of SVs in open sky reception.
- ◆ High Update Rate: up to 10Hz^(note1)
- ◆ 12 multi-tone active interference canceller^(note2) [ISSCC 2011 Award -Section 26.5] (http://isscc.org/doc/2011/isscc2011.advanceprogrambooklet_abstracts.pdf)
- ◆ High accuracy 1-PPS timing support for Timing Applications (10ns jitter)
- ◆ AGPS Support for Fast TTFF (EPO™ Enable 7 days/14 days)
- ◆ EASY™^(note2): Self-Generated Orbit Prediction for instant positioning fix
- ◆ AlwaysLocate™^(note2) Intelligent Algorithm (Advance Power Periodic Mode) for power saving
- ◆ Logger function Embedded^(note2)
- ◆ Automatic antenna switching function
- ◆ Antenna Advisor function
- ◆ Ascenkorea Firmware Customization Services
- ◆ Consumption current(@3.3V):
 - Acquisition: 25mA Typical
 - Tracking: 20mA Typical
- ◆ E911, RoHS, REACH compliant

note 1: SBAS can only be enabled when update rate is less than or equal to 5Hz.

note2: Some features need special firmware or command programmed by customer, please refer to Ascenkorea "GPS command List"



1.3 System Block Diagram

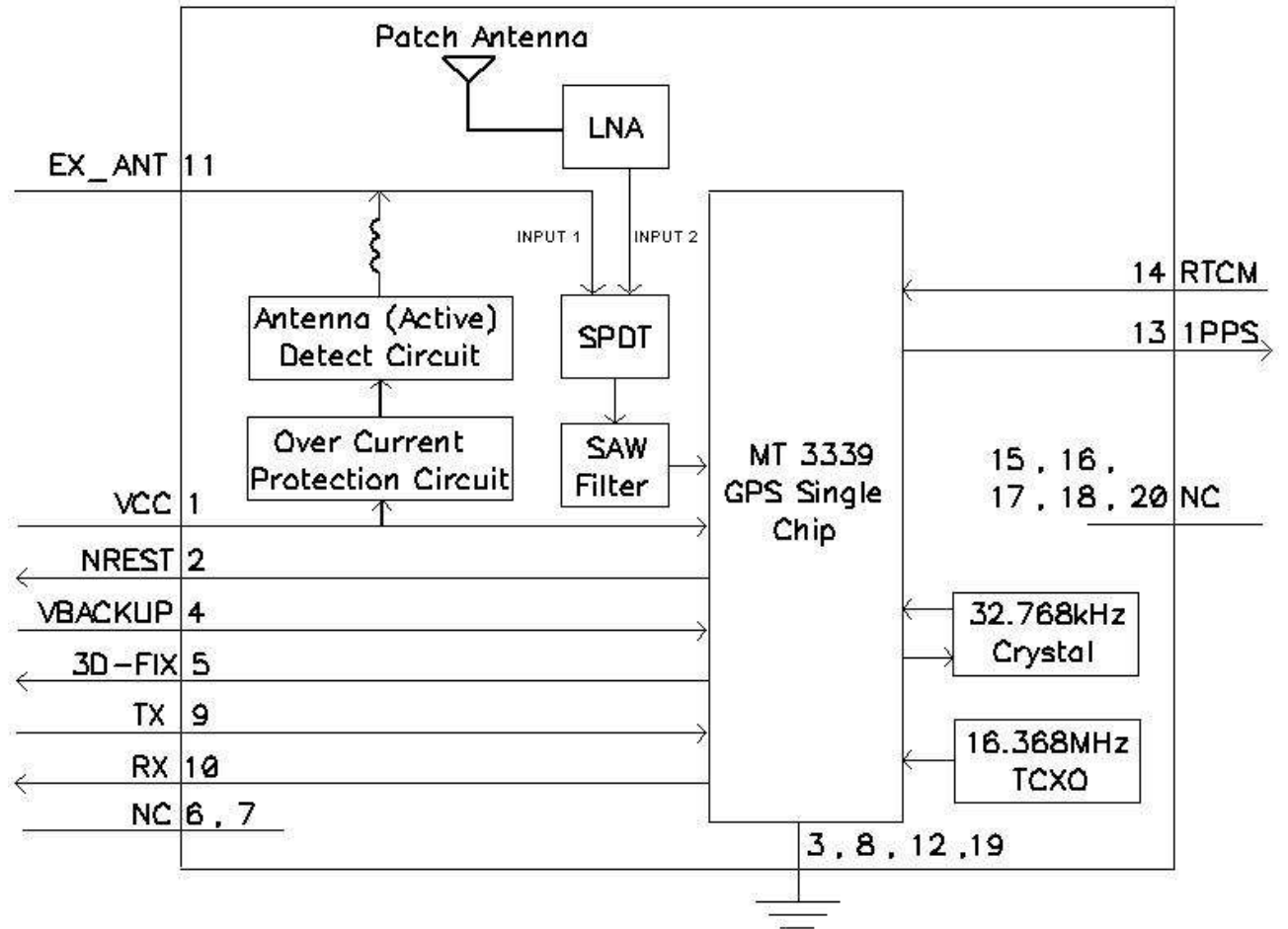



1.4 Multi-tone active interference canceller

Because different application (Wi-Fi, GSM/GPRS, 3G/4G, Bluetooth) are integrated into navigation system, the harmonic of RF signal will influence the GPS reception, The multi-tone active interference canceller (abbr: MTAIC) can reject external RF interference which come from other active components on the main board, to improve the capacity of GPS reception without any needed HW change in the design. PA6H can cancel up to 12 independent channels interference continuous wave (CW)

1.5 1PPS

A pulse per second (1 PPS) is an electrical signal that very precisely indicates the start of a second. Depending on the source, properly operating PPS signals have typical accuracy ranging 10ns.

1 PPS signals are used for precise timekeeping and time measurement. One increasingly common use is in computer timekeeping, including the NTP protocol. A common use for the PPS signal is to connect it to a PC using a low-latency, low-jitter wire connection and allow a program to synchronize to it:

PA6H supply the high accurate 1PPS timing to synchronize to GPS time after 3D-Fix. A power-on output 1pps is also available for customization firmware settings.

1.6 AGPS Support for Fast TTFF (EPO™)

The AGPS (EPO™) supply the predicated Extended Prediction Orbit data to speed TTFF ,users can download the EPO data to GPS engine from the FTP server by internet or wireless network ,the GPS engine will use the EPO data to assist position calculation when the navigation information of satellites are not enough or weak signal zone . About the detail, please link www.ascen.co.kr

1.7 EASY™

The EASY™ is embedded assist system for quick positioning, the GPS engine will calculate and predict automatically the single emperies (Max. up to 3 days)when power on ,and save the predict information into the memory , GPS engine will use these information for positioning if no enough information from satellites, so the function will be helpful for positioning and TTFF improvement under indoor or urban condition.

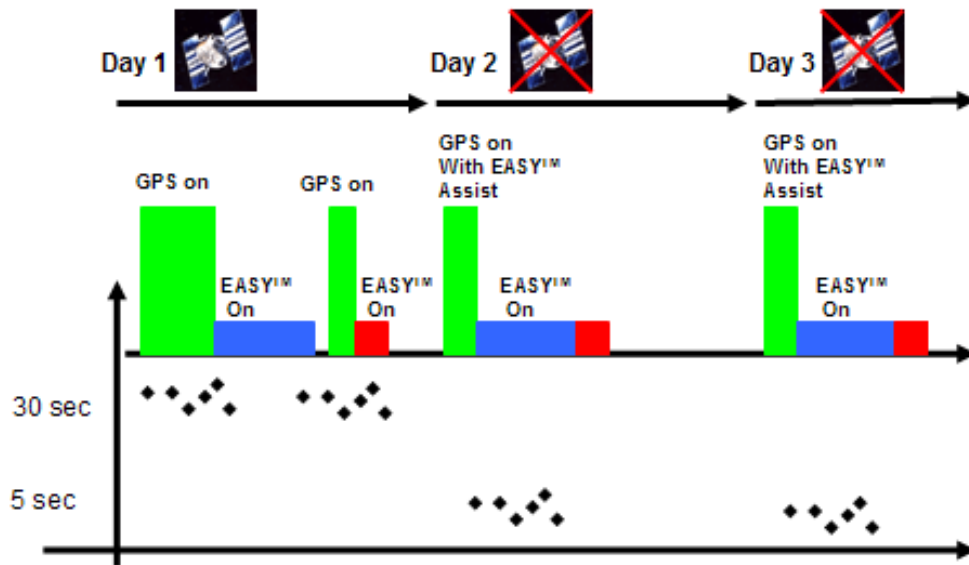

Figure 1.12-1 EASY System operation

Please refer to the Fig 1.12-1, When GPS device great the satellite information from GPS satellites, the GPS engine automatically pre-calculate the predict orbit information for 3 days

The GPS device still can quickly do the positioning with EASY™ function under weak GPS signal.



1.8 AlwaysLocate™ (Advance Power Periodic Mode)

Embedded need to be executed full y all the time , the algorithm can be set by different necessary to decide the operation level of GPS function , reduce power consumption , it will suffer positing accuracy to get the target of power saving and extend the usage time of product . (The positioning accuracy of reporting location < 50m (CEP)

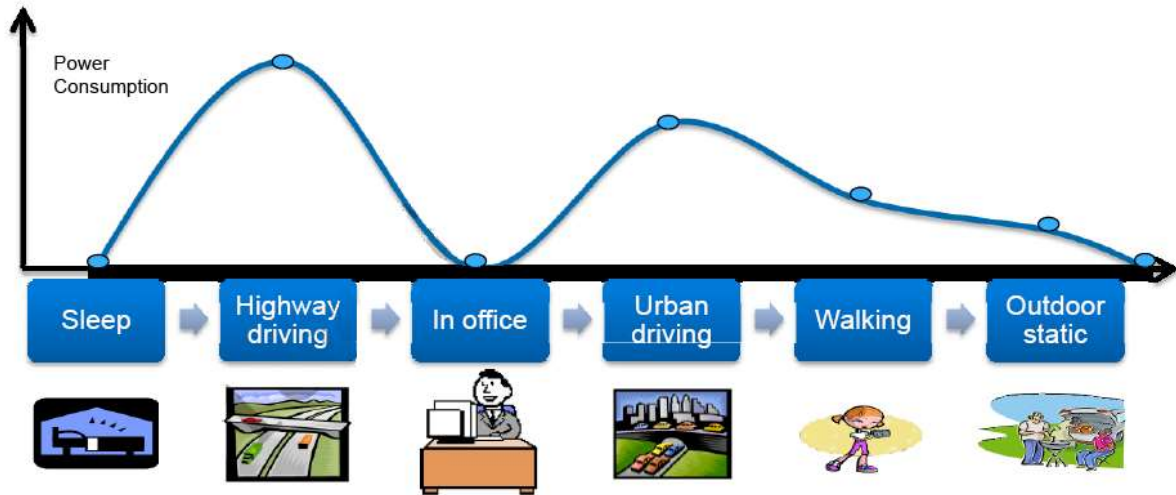

1.9 Embedded Logger function

The Embedded Logger function don't need host CPU (MCU) and external flash to handle the operation , GPS Engine will use internal flash (embedded in GPS chipset) to log the GPS data (Data format : UTC, Latitude , longitude, Valid ,Checksum), the max log days can up to 2 days under AlwaysLocate™ condition .^{Note}

Note: Data size per log was shrunk from 24 bytes to 15 bytes.

2.0 Antenna Advisor

“Antenna Advisor” is a brand new antenna system available exclusively for PA6H. It is designed to detect and notify antenna status using software (through proprietary protocol on **Chapter 3.2**).

Antenna Advisor can detect and notify the following:

- Active Antenna Shorted
- Using Internal Antenna
- Using Active Antenna

This document is the exclusive property of AscenKorea Inc. and should not be distributed, reproduced, into any other format without prior permission of AscenKorea Inc. Specifications subject to change without prior notice.



2. Specification

2.1 Mechanical Dimension

Dimension: (Unit: mm, Tolerance: +/- 0.2mm)

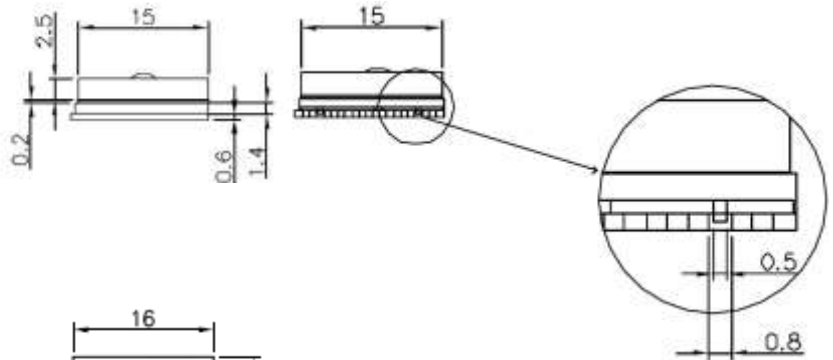
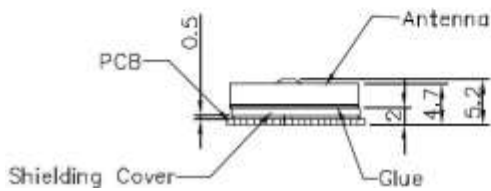
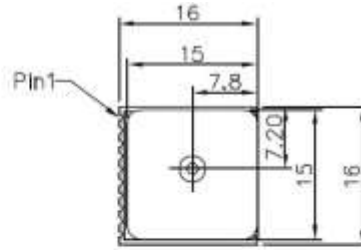

Unit : mm
Assemble Tolerance : 0.2mm

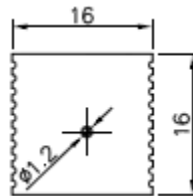

2.2 Recommended PCB pad Layout

(Unit: mm, Tolerance: 0.1mm)

AKS6H Footprint

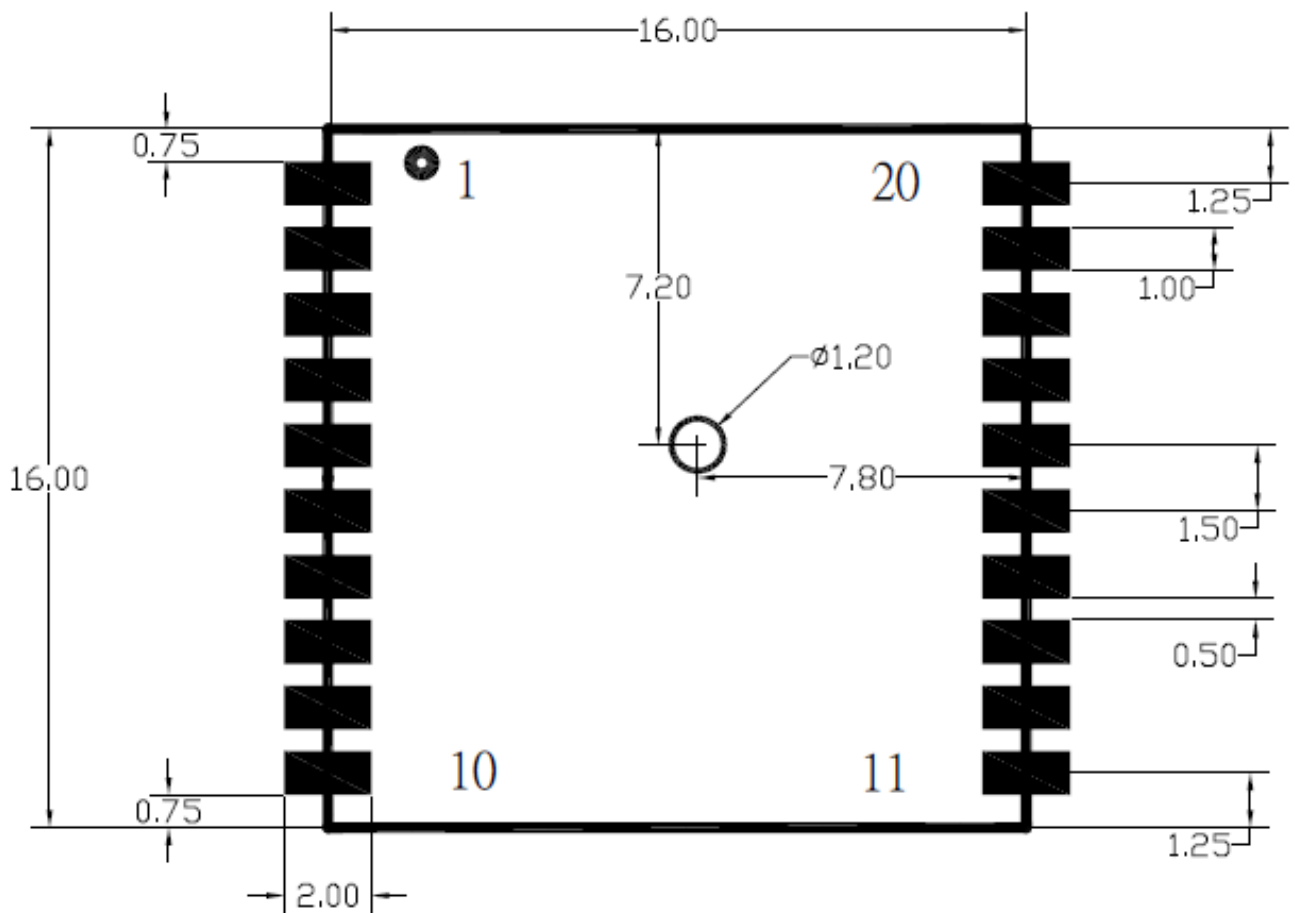

(Top view)

(Unit : mm, Tolerance : 0.1mm)



2.3 Pin Configuration

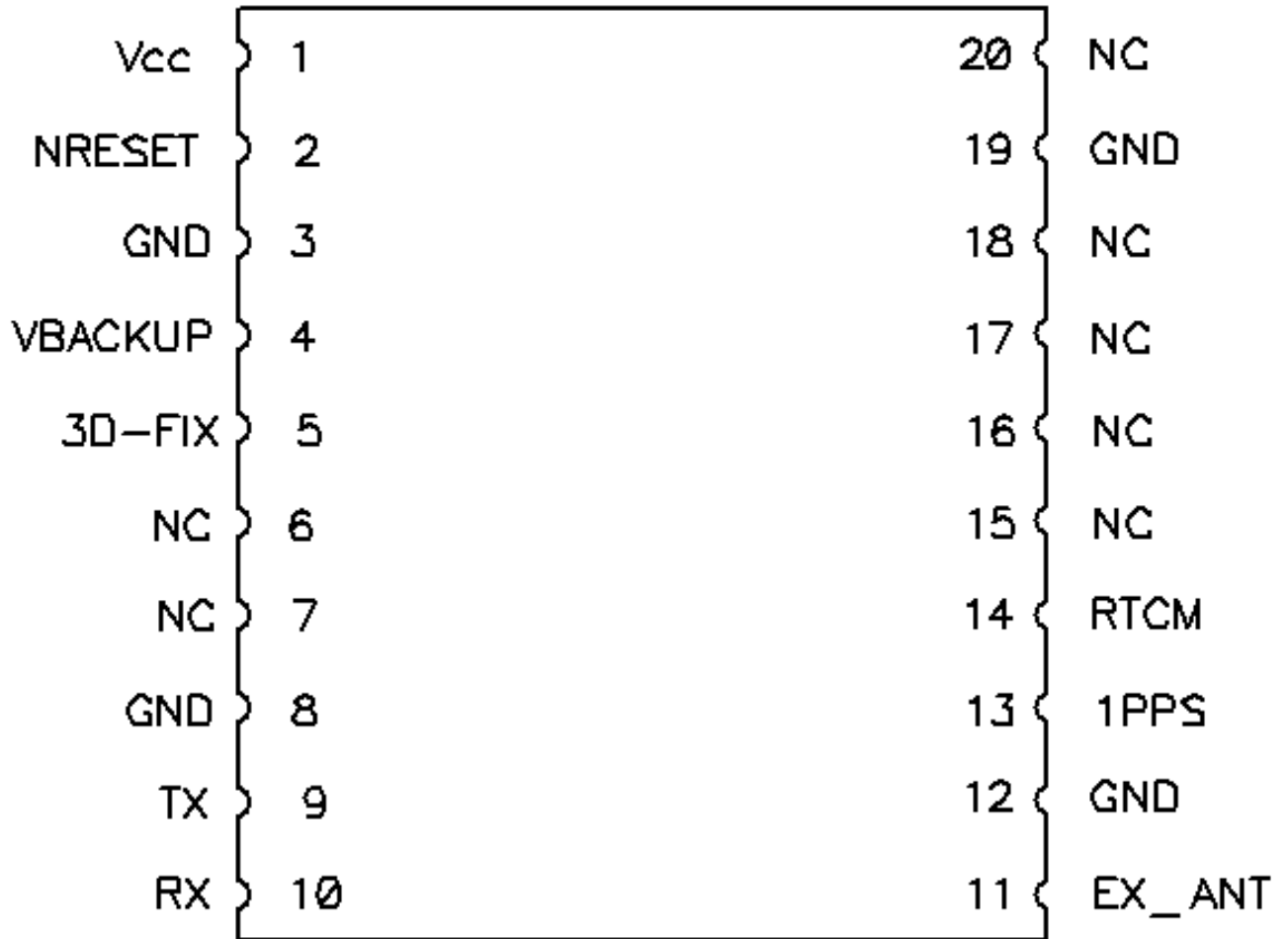

(Top view)



2.4 Pin Assignment

| Pin | Name | I/O | Description & Note |
|-----|---------|---------|---|
| 1 | VCC | PI | Main DC Power Input |
| 2 | NRESET | I | Reset Input, Low Active |
| 3 | GND | P | Ground |
| 4 | VBACKUP | PI | Backup Power Input for RTC & Navigation Data Retention |
| 5 | 3D-FIX | O | 3D-Fix Indicator |
| 6 | NC | -- | Not Connect |
| 7 | NC | -- | Not Connect |
| 8 | GND | P | Ground |
| 9 | TX | O | Serial Data Output for NMEA Output (UART TTL) |
| 10 | RX | I | Serial Data Input for Firmware Update (UART TTL) |
| 11 | EX_ANT | I PO | External active antenna RF input. DC power from VCC and provide for external active antenna. |
| 12 | GND | P | Ground |
| 13 | 1PPS | O | 1PPS Time Mark Output 2.8V CMOS Level |
| 14 | RTCM | I | Serial Data Input for DGPS RTCM Data Streaming |
| 15 | NC | -- | Not Connect |
| 16 | NC | -- | Not Connect |
| 17 | NC | -- | Not Connect |
| 18 | NC | -- | Not Connect |
| 19 | GND | P | Ground |
| 20 | NC | -- | Not Connect |



2.5 Description of I/O Pin

VCC (Pin1)

The main DC power supply of the module, the voltage should be kept between from 3.0V to 4.3V.

The Vcc ripple must be controlled under 50mV_{pp} (Typical: 3.3V)

NRESET (Pin2)

With a low level, it causes the module to reset. If not used, keep floating.

GND (Pin3, Pin8, Pin12, Pin19)

Ground

VBACKUP (Pin4)

This connects to the backup power of the GPS module. Power source (such as battery) connected to this pin will help the GPS chipset in keeping its internal RTC running when the main power source is turned off. The voltage should be kept between **2.0V~4.3V, Typical 3.0V.**

IF VBACKUP power was not reserved, the GPS module will perform a lengthy cold start every time it is powered-on because previous satellite information is not retained and needs to be re-transmitted.

If not used, keep open.

3D-FIX (Pin5)

The 3D-FIX is assigned as a fix flag output. The timing behavior of this pin can be configured by custom firmware for different applications (Example: waking up host MCU). If not used, keep floating.



- Before 2D Fix
The pin should continuously output one-second high-level with one-second low-level signal.

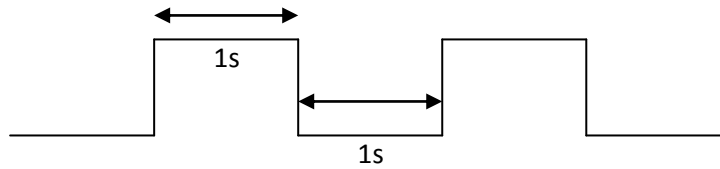

- After 2D or 3D Fix
The pin should continuously output low-level signal.
Low _____

NC (Pin6, Pin7, Pin15, Pin16, Pin17, Pin18, Pin20)

Not connect.

TX (Pin9)

This is the UART transmitter of the module. It outputs the GPS information for application.

RX (Pin10)

This is the UART receiver of the module. It is used to receive software commands and firmware update.

EX_ANT (Pin11)

DC power from VCC and provide for external active antenna (Recommendation: 3.3V).

When a 4mA or higher current is detected, the detect circuit will acknowledge the external antenna as being present and uses external antenna for reception.

In the event of short circuit occurring at external antenna, the module will limit the drawn current to a safe level.

The 3.0V for the GPS external antenna is limited to 25mA.

The 3.3V for the GPS external antenna is limited to 28mA.

The 3.6V for the GPS external antenna is limited to 31mA.



1PPS (Pin13)

This pin provides one pulse-per-second output from the module and synchronizes to GPS time.

Keep floating if not used.

RTCM (Pin14)

This pin receive DGPS data of RTCM protocol (TTL level), if not used keep floating'

RTCM is not enabled by default, please consult Ascenkorea support to enable this feature.



2.6 Specification List

| | Description |
|--------------------------------------|---|
| GPS Solution | MTK MT3339 |
| Frequency | L1, 1575.42MHz |
| Sensitivity¹ | Acquisition: -148dBm, cold start Reacquisition: -163dBm, Hot start Tracking: -165dBm |
| Channel | 66 channels |
| TTF | Hot start: 1 second typical Warm start: 33 seconds typical Cold start: 35 seconds typical (No. of SVs>4, C/N>40dB, PDop<1.5) |
| Position Accuracy | Without aid:3.0m (50% CEP) DGPS(SBAS(WAAS,EGNOS,MSAS)):2.5m (50% CEP) |
| Velocity Accuracy | Without aid : 0.1m/s DGPS(SBAS(WAAS,EGNOS,MSAS,GAGAN)):0.05m/s |
| Timing Accuracy (1PPS Output) | 10 ns(Typical) |
| Altitude | Maximum 18,000m (60,000 feet) |
| Velocity | Maximum 515m/s (1000 knots) |
| Acceleration | Maximum 4G |
| Update Rate | 1Hz (default), maximum 10Hz |
| Baud Rate | 9600 bps (default) |
| DGPS | SBAS(default) [WAAS, EGNOS, MSAS,GAGAN] |
| QZSS | Support(Ranging) |
| AGPS | Support |
| Power Supply | VCC : 3.0V to 4.3V ; VBACKUP : 2.0V to 4.3V |
| Current Consumption | 25mA acquisition, 20mA tracking |
| Working Temperature | -40 °C to +85 °C |
| Dimension | 16 x 16x 4.7mm, SMD |
| Weight | 4g |



2.7 Absolute Maximum Ratings

The voltage applied for VCC should not exceed 4.3VDC.

| | Symbol | Min. | Typ. | Max. | Unit |
|-------------------------------|---------|------|------|------|------|
| Power Supply Voltage | VCC | 3.0 | 3.3 | 4.3 | V |
| Backup battery Voltage | VBACKUP | 2.0 | 3.0 | 4.3 | V |

2.8 Operating Conditions

| | Condition | Min. | Typ. | Max. | Unit |
|--|--------------|------|------|------|------|
| Operation supply Ripple Voltage | — | — | — | 50 | mVpp |
| RX0 TTL H Level | VCC=3.0~4.3V | 2.0 | — | VCC | V |
| RX0 TTL L Level | VCC=3.0~4.3V | 0 | — | 0.8 | V |
| TX0 TTL H Level | VCC=3.0~4.3V | 2.4 | — | 2.8 | V |
| TX0 TTL L Level | VCC=3.0~4.3V | 0 | — | 0.4 | V |
| Current Consumption @ 3.3V, 1Hz Update Rate | Acquisition | — | 25 | — | mA |
| | Tracking | — | 20 | — | mA |
| Backup Power Consumption@ 3V | 25°C | — | 7 | — | uA |

2.9 GPS External Antenna Specification (Recommended)

It is important that the antenna gets a clear view of the sky and is positioned on a surface level to the horizon for best results. The following specification has to meet for the use reference design.

| Characteristic | Specification |
|--------------------|-------------------------------|
| Polarization | Right-hand circular polarized |
| Frequency Received | 1.57542GHz +/- 1.023MHz |
| Power Supply | 3V to 3.6V |
| DC Current | 4mA ~ 20mA at 3.3V |
| Total Gain | >+ 15dBi (Two-stage LNA) |
| Output VSWR | < 2.5 |
| Impedance | 50ohm |
| Noise Figure | <1.5dB |



3. Protocols

3.1 NMEA Output Sentences

Table-1 lists each of the NMEA output sentences specifically developed and defined by MTK for use within MTK products

| Option | Description |
|---------------|--|
| GGA | Time, position and fix type data. |
| GSA | GPS receiver operating mode, active satellites used in the position solution and DOP values. |
| GSV | The number of GPS satellites in view satellite ID numbers, elevation, azimuth, and SNR values. |
| RMC | Time, date, position, course and speed data. Recommended Minimum Navigation Information. |
| VTG | Course and speed information relative to the ground. |



GGA—Global Positioning System Fixed Data. Time, Position and fix related data

Table-2 contains the values for the following example :

\$GPGGA,064951.000,2307.1256,N,12016.4438,E,1,8,0.95,39.9,M,17.8,M,,*65

| Table-2: GGA Data Format | | | |
|--------------------------|------------|--------|---|
| Name | Example | Units | Description |
| Message ID | \$GPGGA | | GGA protocol header |
| UTC Time | 064951.000 | | hhmmss.sss |
| Latitude | 2307.1256 | | ddmm.mmmm |
| N/S Indicator | N | | N=north or S=south |
| Longitude | 12016.4438 | | dddmm.mmmm |
| E/W Indicator | E | | E=east or W=west |
| Position Indicator | Fix 1 | | See Table-3 |
| Satellites Used | 8 | | Range 0 to 14 |
| HDOP | 0.95 | | Horizontal Dilution of Precision |
| MSL Altitude | 39.9 | meters | Antenna Altitude above/below mean-sea-level |
| Units | M | meters | Units of antenna altitude |
| Geoidal Separation | 17.8 | meters | |
| Units | M | meters | Units of geoids separation |
| Age of Diff. Corr. | | second | Null fields when DGPS is not used |
| Checksum | *65 | | |
| <CR> <LF> | | | End of message termination |

| Table-3: Position Fix Indicator | |
|---------------------------------|----------------------|
| Value | Description |
| 0 | Fix not available |
| 1 | GPS fix |
| 2 | Differential GPS fix |



GSA—GNSS DOP and Active Satellites

Table-4 contains the values for the following example :

\$GPGSA,A,3,29,21,26,15,18,09,06,10,,,,,2.32,0.95,2.11*00

| Table-4: GSA Data Format | | | |
|--------------------------|---------|-------|----------------------------------|
| Name | Example | Units | Description |
| Message ID | \$GPGSA | | GSA protocol header |
| Mode 1 | A | | See Table-5 |
| Mode 2 | 3 | | See Table-6 |
| Satellite Used | 29 | | SV on Channel 1 |
| Satellite Used | 21 | | SV on Channel 2 |
| | | | |
| Satellite Used | | | SV on Channel 12 |
| PDOP | 2.32 | | Position Dilution of Precision |
| HDOP | 0.95 | | Horizontal Dilution of Precision |
| VDOP | 2.11 | | Vertical Dilution of Precision |
| Checksum | *00 | | |
| <CR> <LF> | | | End of message termination |

| Table-5: Mode 1 | |
|-----------------|--|
| Value | Description |
| M | Manual—forced to operate in 2D or 3D mode |
| A | 2D Automatic—allowed to automatically switch 2D/3D |

| Table-6: Mode 2 | |
|-----------------|-------------------------|
| Value | Description |
| 1 | Fix not available |
| 2 | 2D (< 4 SVs used) |
| 3 | 3D (≥ 4 SVs used) |



GSV—GNSS Satellites in View

Table-7 contains the values for the following example :

\$GPGSV,3,1,09,29,36,029,42,21,46,314,43,26,44,020,43,15,21,321,39*7D

\$GPGSV,3,2,09,18,26,314,40,09,57,170,44,06,20,229,37,10,26,084,37*77

\$GPGSV,3,3,09,07,,,26*73

| Table-7: GSV Data Format | | | |
|--------------------------|---------|---------|--|
| Name | Example | Units | Description |
| Message ID | \$GPGSV | | GSV protocol header |
| Number of Messages | 3 | | Range 1 to 3 <i>(Depending on the number of satellites tracked, multiple messages of GSV data may be required.)</i> |
| Message Number1 | 1 | | Range 1 to 3 |
| Satellites in View | 09 | | |
| Satellite ID | 29 | | Channel 1 (Range 1 to 32) |
| Elevation | 36 | degrees | Channel 1 (Maximum 90) |
| Azimuth | 029 | degrees | Channel 1 (True, Range 0 to 359) |
| SNR (C/No) | 42 | dBHz | Range 0 to 99, (null when not tracking) |
| | | | |
| Satellite ID | 15 | | Channel 4 (Range 1 to 32) |
| Elevation | 21 | degrees | Channel 4 (Maximum 90) |
| Azimuth | 321 | degrees | Channel 4 (True, Range 0 to 359) |
| SNR (C/No) | 39 | dBHz | Range 0 to 99, (null when not tracking) |
| Checksum | *7D | | |
| <CR> <LF> | | | End of message termination |



RMC—Recommended Minimum Navigation Information

Table-8 contains the values for the following example :

\$GPRMC,064951.000,A,2307.1256,N,12016.4438,E,0.03,165.48,260406,3.05,W,A*2C

| Table-8: RMC Data Format | | | |
|--------------------------|------------|---------|--|
| Name | Example | Units | Description |
| Message ID | \$GPRMC | | RMC protocol header |
| UTC Time | 064951.000 | | hhmmss.sss |
| Status | A | | A=data valid or V=data not valid |
| Latitude | 2307.1256 | | ddmm.mmmm |
| N/S Indicator | N | | N=north or S=south |
| Longitude | 12016.4438 | | dddmm.mmmm |
| E/W Indicator | E | | E=east or W=west |
| Speed over Ground | 0.03 | knots | |
| Course over Ground | 165.48 | degrees | True |
| Date | 260406 | | ddmmyy |
| Magnetic Variation | 3.05, W | degrees | E=east or W=west (Need Ascenkorea Customization Service) |
| Mode | A | | A= Autonomous mode D= Differential mode E= Estimated mode |
| Checksum | *2C | | |
| <CR> <LF> | | | End of message termination |



VTG—Course and speed information relative to the ground

Table-9 contains the values for the following example:

\$GPVTG,165.48,T,,M,0.03,N,0.06,K,A*37

| Table-9: VTG Data Format | | | |
|--------------------------|---------|---------|---|
| Name | Example | Units | Description |
| Message ID | \$GPVTG | | VTG protocol header |
| Course | 165.48 | degrees | Measured heading |
| Reference | T | | True |
| Course | | degrees | Measured heading |
| Reference | M | | Magnetic (Need Ascenkorea Customization Service) |
| Speed | 0.03 | knots | Measured horizontal speed |
| Units | N | | Knots |
| Speed | 0.06 | km/hr | Measured horizontal speed |
| Units | K | | Kilometers per hour |
| Mode | A | | A= Autonomous mode D= Differential mode E= Estimated mode |
| Checksum | *06 | | |
| <CR> <LF> | | | End of message termination |



3.2 Antenna Status Protocol (Antenna Advisor)

The function is for external active antenna only.

PASCENKOREA—Status of antenna

Table-12 contains the values for the following example:

\$PASCENKOREA,11,3 *6F

| Table-12: PGACK Data Format | | | |
|-----------------------------|---------------|-------|-------------------------|
| Name | Example | Units | Description |
| Message ID | \$PASCENKOREA | | Protocol header |
| Command ID | 11 | | Function Type |
| Reference | 3 | | Value of antenna status |

Example:

\$PASCENKOREA,11,value*checksum

Value: 1=>Active Antenna Shorted

2=>Using Internal Antenna

3=>Using Active Antenna

3.3 MTK NMEA Command Protocols

Packet Type:

103 PMTK_CMD_COLD_START

Packet Meaning:

Cold Start : Don't use Time, Position, Almanacs and Ephemeris data at re-start.

Example:

\$PMTK103*30<CR><LF>



3.4 Firmware Customization Services

Ascenkorea also offers flexible, value-adding GPS firmware customization services that maximizes the over system efficiencies and power consumptions. Latest functions like Binary Mode, 1-Sentence Output, Geo-fencing and Last Position Retention, please see our website at www.Ascenkorea-tech.com under Products / GPS Modules / Software Services for more details.

Note: Not all firmware customization services listed below are supported by module. Please contact Ascenkorea Sales or Technical Support for more details.

4. Reference Design

This chapter introduces the reference schematic design for the best performance. Additional tips and cautions on design are well documented on Application Note, which is available upon request.

4.1 Reference Design Circuit

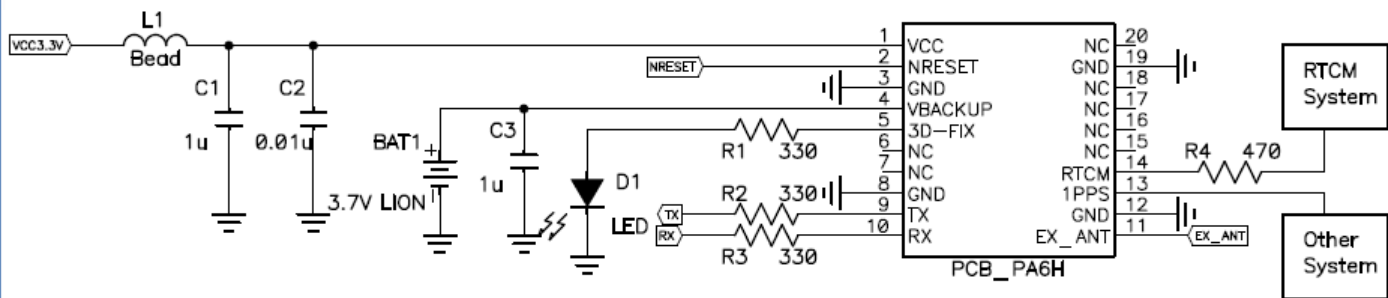

Note:

1. Ferrite bead L1 is added for power noise reduction.
2. C1 and C2 bypass should be put near the module.
3. Damping resistors R2,R3,R4 could be modified based on system application for EMI.
4. If you need more support and information on antenna implementation, please directly contact us at sales@Ascenkorea-tech.com for further services.



5. Packing and Handling

GPS modules, like any other SMD devices, are sensitive to moisture, electrostatic discharge, and temperature. By following the standards outlined in this document for AscenKorea GPS module storage and handling, it is possible to reduce the chances of them being damaged during production set-up. This document will go through the basics on how AscenKorea packages its modules to ensure they arrive at their destination without any damages and deterioration to performance quality, as well as some cautionary notes before going through the surface mount process.

⚠ Please read the sections II to V carefully to avoid damages permanent damages due to moisture intake

⚠ GPS receiver modules contain highly sensitive electronic circuits and are electronic sensitive devices and improper handling without ESD protections may lead to permanent damages to the modules. Please read section VI for more details.

5.1 Moisture Sensitivity

AscenKorea GPS modules are moisture sensitive, and must be pre-baked before going through the solder reflow process. It is important to know that:

AscenKorea GPS modules must complete solder reflow process in 72 hours after pre-baking.

This maximum time is otherwise known as “Floor Life”

If the waiting time has exceeded 72 hours, it is possible for the module to suffer damages during the solder reflow process such as cracks and delamination of the SMD pads due to excess moisture pressure.

5.2 Tape Reel Packing Information 1Kpcs/Reel

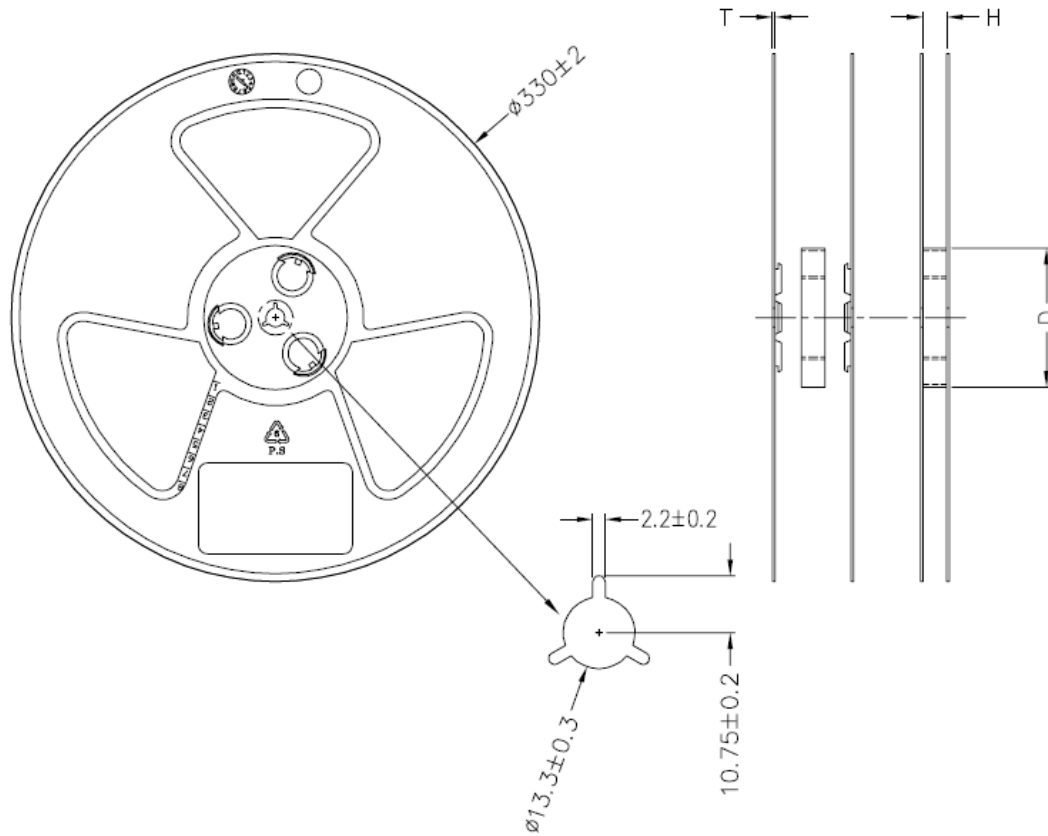

Spec: H: 24.5 ± 1.5 , T: 2.2 ± 0.2 , D: 99 ± 1.5

Note: 13" Reel, Material : P.S

Unit: (mm)

Figure 1: Reel Dimension

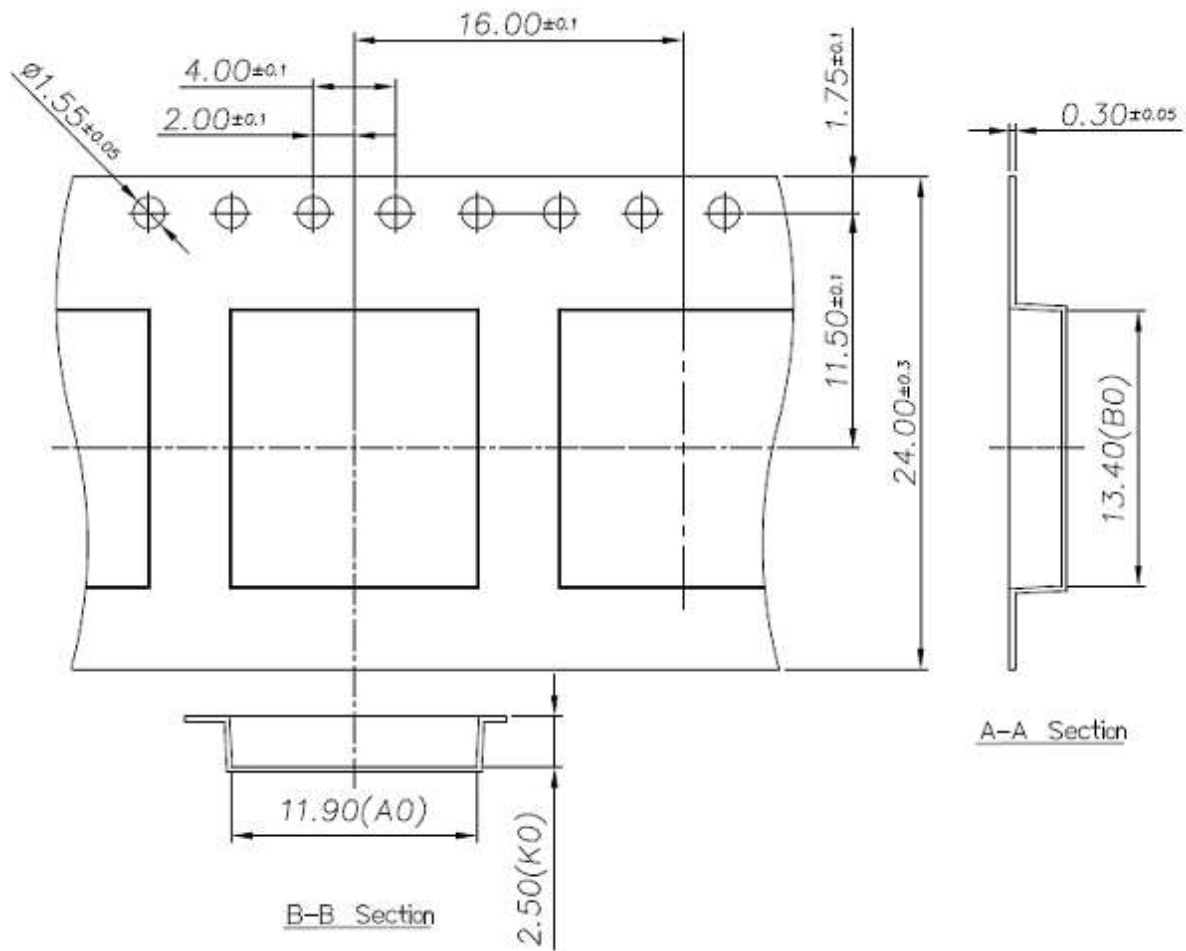

| | |
|----|-----------|
| A0 | 11.9±0.10 |
| B0 | 13.4±0.10 |
| K0 | 2.5±0.10 |

Unit: (mm)

Figure 2: Tape Dimension

The moisture color coded card provides an insight to the relative humidity percentage (RH). When the GPS modules are taken out, it should be around or lower than 30% RH level.

Outside each electrostatic bag is a caution label for moisture sensitive device.

HUMISENSOR®

| | | |
|--------------------------------|-----|--|
| EXAMINE ITEM IF PINK | 50% | |
| CHANGE DESICCANT IF PINK | 40% | |
| WARNING IF PINK | 30% | |

AVOID METAL CONTACT

Caution
Moisture Sensitive

Caution

This bag contains
MOISTURE-SENSITIVE &
ELECTROSTATIC SENSITIVE DEVICES

1. Calculated shelf life in package bag: **6 months** at < 30 °C and < 60% relative humidity (RH)
 - a. Temperature and Humidity must be controlled in SMT production line and storage area. Temperature of **23 ° C, 60% +/-5% RH** humidity is highly recommended. (please refer to IPQC for more information)
2. **Devices require bake before mounting and subjected to reflow solder**
3. After baking, devices that will be subjected to reflow solder or other high temperature process must be **mounted within 72 hours of factory conditions ≤ 30°C/60% RH**
4. Peak package body temperature: **250 +0 /-5 °C**
 - a. The reflow temperature and its profile data must be measured before the SMT process and match the levels and guidelines set by IPQC.
 - b. When performing solder paste printing please check if the amount of solder paste is in excess or insufficient, as both conditions may lead to defects such as electrical shortage, empty solder and etc.
 - c. The usage of solder paste should follow "first in first out" principle. Opened solder paste needs to be monitored and recorded in a timely fashion (Please refer to IPQC for more info).

Bag Seal Date: (1.1.2010)

Figure 3: Example of moisture color coded card and caution label



5.3 Storage and Floor Life Guideline

Since AscenKorea modules must undergo solder-reflow process in 72 hours after it has gone through pre-baking procedure, therefore if it is not used by then, it is recommended to store the GPS modules in dry places such as dry cabinet.

The approximate shelf life for AscenKorea GPS modules packages is 6 months from the bag seal date, when store in a non-condensing storage environment (<30°C/60% RH)

⚠ It is important to note that it is a required process for AscenKorea GPS modules to undergo pre-baking procedures, regardless of the storage condition.

5.4 Drying

Because the vapor pressures of moisture inside the GPS modules increase greatly when it is exposed to high temperature of solder reflow, in order to prevent internal delaminating, cracking of the devices, or the “popcorn” phenomenon, it is a **necessary requirement** for AscenKorea GPS module to undergo pre-baking procedure before any high temperature or solder reflow process.

The recommendation baking time for AscenKorea GPS module is as follows:

- ✓ **60°C for 8 to 12 hours**

Once baked, the module’s floor life will be “reset”, and has additional 72 hours in normal factory condition to undergo solder reflow process.

⚠ Please limit the number of times the GPS modules undergoes baking processes as repeated baking process has an effect of reducing the wetting effectiveness of the SMD pad contacts. This applies to all SMT devices.

⚠ Oxidation Risk: Baking SMD packages may cause oxidation and/or intermetallic growth of the terminations, which if excessive can result in solderability problems during board assembly. The temperature and time for baking SMD packages are therefore limited by solderability considerations. The cumulative bake time at a temperature greater than 90°C and up to 125°C shall not exceed 96 hours. Bake temperatures higher than 125°C are now allowed.



5.5 ESD Handling



Please carefully follow the following precautions to prevent severe damage to GPS modules.

AscenKorea GPS modules are sensitive to electrostatic discharges, and thus are Electrostatic Sensitive Devices (ESD). Careful handling of the GPS modules and in particular to its patch antenna (if included) and RF_IN pin, must follow the standard ESD safety practices:

- ✓ Unless there is a galvanic coupling between the local GND and the PCB GND, then the first point of contact when handling the PCB shall always be between the local GND and PCB GND.
- ✓ Before working with RF_IN pin, please make sure the GND is connected
- ✓ When working with RF_IN pin, do not contact any charges capacitors or materials that can easily develop or store charges such as patch antenna, coax cable, soldering iron.
- ✓ Please do not touch the mounted patch antenna to prevent electrostatic discharge from the RF input
- ✓ When soldering RF_IN pin, please make sure to use an ESD safe soldering iron (tip).



6. Reflow Soldering Temperature Profile

The following reflow temperature profile was evaluated by Ascenkorea and has been proven to be reliable qualitatively. Please contact us beforehand if you plan to solder this component using a deviated temperature profile as it may cause significant damage to our module and your device.

All the information in this sheet can only be used only for Pb-free manufacturing process.

6.1 SMT Reflow Soldering Temperature Profile (Reference Only)

Average ramp-up rate (25 ~ 150°C): 3°C/sec. max.

Average ramp-up rate (270°C to peak): 3°C/sec. max.

Preheat: 175 ± 25°C, 60 ~ 120 seconds

Temperature maintained above 217°C: 60~150 seconds

Peak temperature: 250 +0/-5°C, 20~40 seconds

Ramp-down rate: 6°C/sec. max.

Time 25°C to peak temperature: 8 minutes max.

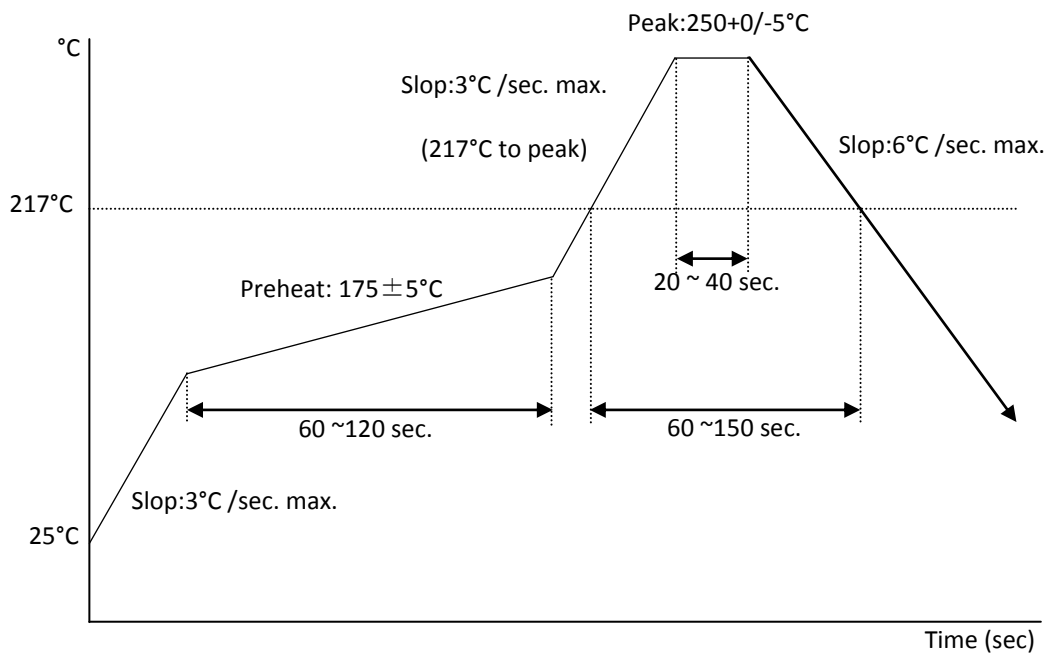



| | Details | Suggestions | Notes |
|---|---|--|---|
| 1 | Before proceeding with the reflow-soldering process, the GPS module must be pre-baked. | Pre-bake Time: 6 Hours @ 60°±5°C or 4 Hours @ 70°±5°C | The maximum tolerated temperature for the tray is 100°C. After the pre-baking process, please make sure the temperature is sufficiently cooled down to 35°C or below in order to prevent any tray deformation. |
| 2 | Because PCBA (along with the patch antenna) is highly endothermic during the reflow-soldering process, extra care must be paid to the GPS module's solder joint to see if there are any signs of cold weld(ing) or false welding. | The parameters of the reflow temperature must be set accordingly to module's reflow-soldering temperature profile. | Double check to see if the surrounding components around the GPS module are displaying symptoms of cold weld(ing) or false welding. |
| 3 | Special attentions are needed for PCBA board during reflow-soldering to see if there are any symptoms of bending or deformation to the PCBA board, possibility due to the weight of the module. If so, this will cause concerns at the latter half of the production process. | A loading carrier fixture must be used with PCBA if the reflow soldering process is using rail conveyors for the production. | If there is any bending or deformation to the PCBA board, this might causes the PCBA to collide into one another during the unloading process. |
| 4 | Before the PCBA is going through the reflow-soldering process, the production operators must check by eyesight to see if there are positional offset to the module, because it will be difficult to readjust after the module has gone through reflow-soldering process. | The operators must check by eyesight and readjust the position before reflow-soldering process. | If the operator is planning to readjust the module position, please do not touch the patch antenna while the module is hot in order to prevent rotational offset between the patch antenna and module |

Note: References to patch antenna is referred to GPS modules with integrated Patch-on-top antennas (PA/Gms Module Series), and may not be applicable to all GPS modules.



| | Details | Suggestions | Notes |
|---|---|---|--|
| 5 | Before handling the PCBA, they must be cooled to 35°C or below after they have gone through the reflow-soldering process, in order to prevent positional shift that might occur when the module is still hot. | <ol style="list-style-type: none">1. Can use electric fans behind the Reflow machine to cool them down.2. Cooling the PCBA can prevent the module from shifting due to fluid effect. | It is very easy to cause positional offset to the module and its patch antenna when handling the PCBA under high temperature. |
| 6 | <ol style="list-style-type: none">1. When separating the PCBA panel into individual pieces using the V-Cut process, special attentions are needed to ensure there are sufficient gap between patch antennas so the patch antennas are not in contact with one another.2. If V-Cut process is not available and the pieces must be separated manually, please make sure the operators are not using excess force which may cause rotational offset to the patch antennas. | <ol style="list-style-type: none">1. The blade and the patch antenna must have a distance gap greater than 0.6mm.2. Do not use patch antenna as the leverage point when separating the panels by hand. | <ol style="list-style-type: none">1. Test must be performed first to determine if V-Cut process is going to be used. There must be enough space to ensure the blade and patch antenna do not touch one another.2. An uneven amount of manual force applied to the separation will likely to cause positional shift in patch antenna and module. |
| 7 | When separating panel into individual pieces during latter half of the production process, special attentions are needed to ensure the patch antennas do not come in contact with one another in order to prevent chipped corners or positional shifts. | Use tray to separate individual pieces. | It is possible to chip corner and/or cause a shift in position if patch antennas come in contact with each other. |

Note: References to patch antenna is referred to GPS modules with integrated Patch-on-top antennas (PA/Gms Module Series), and may not be applicable to all GPS modules.



Other Cautionary Notes on Reflow-Soldering Process:

1. Module must be pre-baked **before** going through SMT solder reflow process.
2. The usage of solder paste should follow “first in first out” principle. Opened solder paste needs to be monitored and recorded in a timely fashion (can refer to IPQC for related documentation and examples).
3. Temperature and humidity must be controlled in SMT production line and storage area. Temperature of 23°C, 60±5% RH humidity is recommended. (please refer to IPQC for related documentation and examples)
4. When performing solder paste printing, please notice if the amount of solder paste is in excess or insufficient, as both conditions may lead to defects such as electrical shortage, empty solder and etc.
5. Make sure the vacuum mouthpiece is able to bear the weight of the GPS module to prevent positional shift during the loading process.
6. Before the PCBA is going through the reflow-soldering process, the operators should check by eyesight to see if there are positional offset to the module.
7. The reflow temperature and its profile data must be measured before the SMT process and match the levels and guidelines set by IPQC.
8. If SMT protection line is running a double-sided process for PCBA, please process GPS module during the second pass only to avoid repeated reflow exposures of the GPS module. Please contact Ascenkorea beforehand if you must process GPS module during the 1st pass of double-side process.

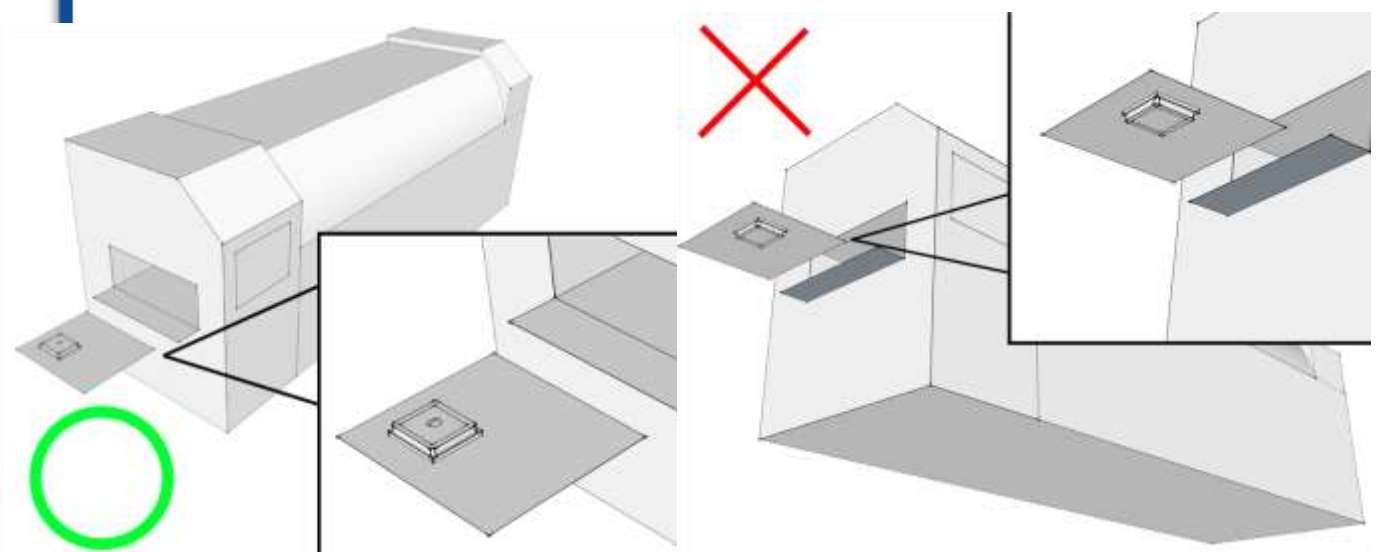

Figure 6.2: Place GPS module right-side up when running reflow-solder process, do not invert.

This document is the exclusive property of Ascenkorea Inc. and should not be distributed, reproduced, into any other format without prior permission of Ascenkorea Inc. Specifications subject to change without prior notice.



9. Module must be pre-baked **before** going through SMT solder reflow process.
10. The usage of solder paste should follow “first in first out” principle. Opened solder paste needs to be monitored and recorded in a timely fashion (can refer to IPQC for related documentation and examples).
11. Temperature and humidity must be controlled in SMT production line and storage area. Temperature of 23°C, 60±5% RH humidity is recommended. (please refer to IPQC for related documentation and examples)
12. When performing solder paste printing, please notice if the amount of solder paste is in excess or insufficient, as both conditions may lead to defects such as electrical shortage, empty solder and etc.
13. The reflow temperature and its profile data must be measured before the SMT process and match the levels and guidelines set by IPQC.

6.2 Manual Soldering

Soldering iron:

Bit Temperature: Under 380°C Time: Under 3 sec.

Notes:

1. Please do not directly touch the soldering pads on the surface of the PCB board, in order to prevent further oxidation
2. The solder paste must be defrosted to room temperature before use so it can return to its optimal working temperature. The time required for this procedure is unique and dependent on the properties of the solder paste used.
3. The steel plate must be properly assessed before and after use, so its measurement stays strictly within the specification set by SOP.
4. Please watch out for the spacing between soldering joint, as excess solder may cause electrical shortage
5. Please exercise with caution and do not use extensive amount of flux due to possible siphon effects on neighboring components, which may lead to electrical shortage.
6. Please do not use the heat gun for long periods of time when removing the shielding or inner components of the GPS module, as it is very likely to cause a shift to the inner components and will leads to electrical shortage.



7. Contact Us

AscenKorea Inc.

Rm. 710, 7F, Halla Sigma Valley B/D, Gasandigital 2Ro
53, Geumcheon-gu, Seoul, Korea

Tel: +82 02 858 7810 Fax: +82 02 858 7813

www.AscenKorea.com /

Sales & Support Email : sales@ascen.co.kr